

PRODUCT DISCLAIMER

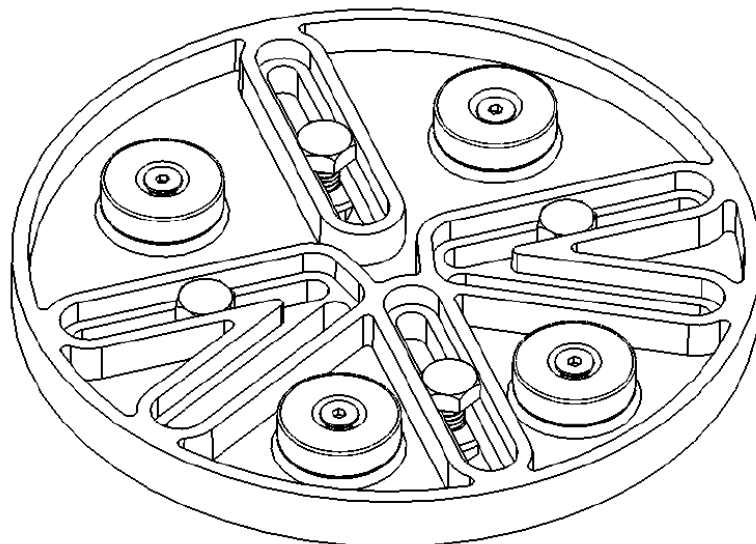
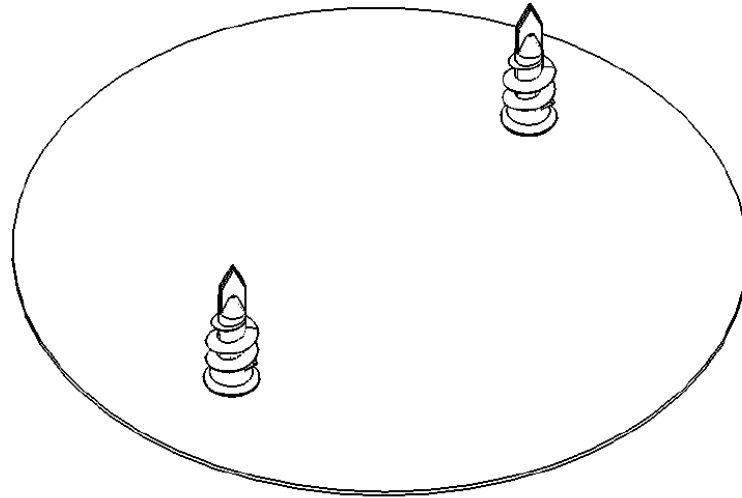

QUICK MOUNT DISCLAIMER

DISCLAIMER

Quick Mount LLC and its associated members, intend to make this all documentation accurate and complete. However, Quick Mount LLC makes no claim that the information contained herein covers all details, conditions, or variations, nor does it provide for every possible contingency in connection with the installation or use of this product. The information contained in this document is subject to change without notice or obligation of any kind. Quick Mount assumes no responsibility for accuracy, completeness or sufficiency of the information contained in this document.

Quick Projector Mount is patent pending, all rights reserved.





IMPORTANT WARNINGS AND CAUTIONS!

 **WARNING:** A WARNING alerts you to the possibility of serious injury or death if you do not follow the instructions.

 **CAUTION:** A CAUTION alerts you to the possibility of damage or destruction of equipment if you do not follow the corresponding instructions.

 **WARNING:** Failure to read, thoroughly understand, and follow all instructions can result in serious personal injury, damage to equipment, or void of factory warranty! It is the installer's responsibility to make sure all components are properly assembled and installed using the instructions provided.

 **WARNING:** Failure to provide adequate structural strength for this component can result in serious personal injury or damage to equipment! It is the installers responsibility to make sure the structure to which this component is attached can support five times the combined weight of all equipment. Reinforce the structure as required before installing the component. The ceiling to which the mount is being attached may have a maximum drywall thickness of 5/8" (1.6cm) and a minimum of 1/2" (1.27cm). The ceiling must also have NO angle, as the magnetic force will decrease under an angled load.

 **WARNING:** Exceeding the weight capacity can result in serious personal injury, damage to equipment, or damage to other surrounding items! It is the installer's responsibility to make sure the combined weight of all components located at the Quick Projector Mount does not exceed 25lbs (11.3kg). Use with products heavier than the maximum weight may result in collapse of the mount and its accessories cause possible injury

 **WARNING:** Cables (including power, USB, HDMI, and more) should be routed to avoid creating electric, tripping or any other safety hazards

 **WARNING:** This product contains small items that could be a choking hazard if swallowed. Before starting assembly, verify all parts included are undamaged. Do not use damaged or defective parts. Keep all pieces of the assembly away from children and animals



PRE-REQUISITS:

Ensure that the projector is mounted properly to selected ceiling mount of choice. Follow the exact product instructions prior to attempting installation of Quick Projector Mount. If you do not understand the instructions or have any concerns or questions, please contact the products technical support or Quick Mount customer service at support@quickmountproducts.com

WARNINGS:

- ⚠️ AVOID POTENTIAL INJURY OR PROPERTY DAMAGE, DO NOT OVERTIGHTEN THE SCREWS. TIGHTEN UNTIL THE PLATE IS PRESSED FIRMLY AGAINST THE CEILING.
- ⚠️ FAILURE TO PROPERLY INSTALL THE CEILING PLATE CAN RESULT IN SERIOUS INJURY OR DEATH.
- ⚠️ ADJUST THE PROJECTOR MOUNT PLATE SO THAT THE CENTER IS ALIGNED WITH THE CENTER OF PROJECTOR AND CEILING MOUNT.
- ⚠️ ENSURE THE CENTER OF THE CEILING MOUNT PLATE IS LOCATED WITHIN THE CIRCLED AREA HIGHLIGHTED ABOVE. KEEPING THE MASS CENTERED ON THE QUICK MOUNT PLATE WILL CREATE A STRONGER MAGNETIC CONNECTION BETWEEN THE PROJECTOR MOUNT AND THE CEILING PLATE.
- ⚠️ MAKE SURE THAT THE PROJECTOR ASSEMBLY DOES NOT EXCEED 25LBS (11.3KG)
- ⚠️ MAKE SURE THERE IS NO DEBRIS BETWEEN THE QUICK MOUNT PLATE AND CEILING PLATE. THE MAGNETS MUST BE CLEAN TO ENSURE A STRONG CONNECTION TO CEILING.
- ⚠️ MAKE SURE THAT ALL BODY PARTS ARE CLEAR FROM THE MATING SURFACES
- ⚠️ USE CAUTION NOT TO SLIDE THE ASSEMBLY WHEN INSTALLING OR REMOVING FROM CEILING. SLIDING CAN CAUSE SCRATCHES OR DAMAGE TO THE CEILING PLATE. SEPARATING ONE SIDE AT A TIME USING A DOWNWARD LINEAR FORCE IS THE RECOMMENDED METHOD.
- ⚠️ BE SURE TO HAVE A GOOD GRIP ON THE PROJECTOR ASSEMBLY WHEN REMOVING, PULLING FROM THE MOUNT AND NOT THE PROJECTOR.
- ⚠️ QUICK MOUNT LLC IS NOT LIABLE OR RESPONSIBLE FOR ANY DAMAGES, INJURY OR DEATH RESULTING FROM IMPROPER MOUNTING, USE, OR HANDLING OF PROJECTOR ASSEMBLY OR ANY QUICK MOUNT RELATED PRODUCTS.